

Installation Instructions

Ground Fixed
Rainbow Sambas
Page 1 of 4

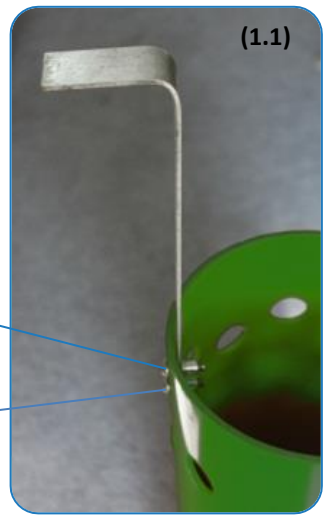

Instrument Components:
Rainbow Sambas are pre-assembled



Weight of heaviest part **14.6kg** (XL Samba)

1. Assemble fixing brackets to base of sambas using M8x25mm security screws and lock washers. (1.1)(See Assembly Guide)

2. Arrange Sambas in desired location and mark holes for excavation. Each hole should be 80-100mm larger than the drum itself.

3. Excavate marked holes to 300mm depth making sure the holes have a level base allow the sambas to sit vertical.

4. Once happy with location of the sambas, fill holes using rapid hardening concrete. Be sure to compact concrete around metal brackets and leave to dry according to manufactures guidelines.

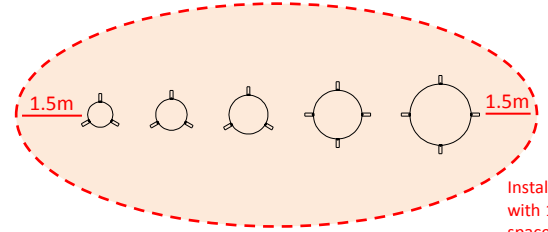

Install Instrument with 1.5m free space (from widest point) around it.

Sambas will arrive on site in pre set heights. In ground fixing depth 300mm for all 5 sambas.

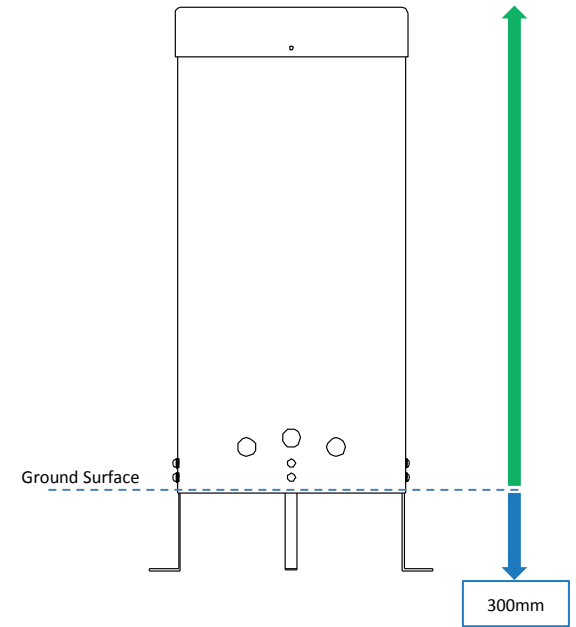

Ground Fix Components:



Spares available form percussionplay.co.uk or from your local distributor

47 Kg

Tools:



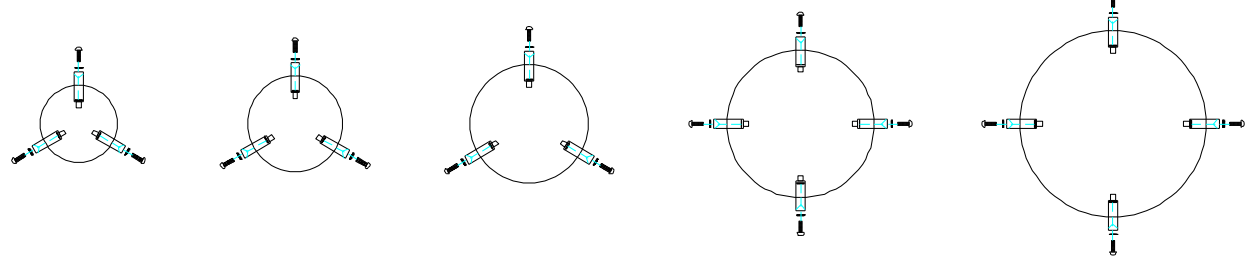

x1
TX 40 Driver Bit

Ground Fixed
Rainbow Sambas
Page 2 of 4



PPRASA PLAN

COMPONENTS LIST:

-  M8x25 Pin torx X34
-  M8 Lock washer X34
-  Ground Fix L Bracket X17

Instrument Components:

Rainbow Sambas are pre-assembled

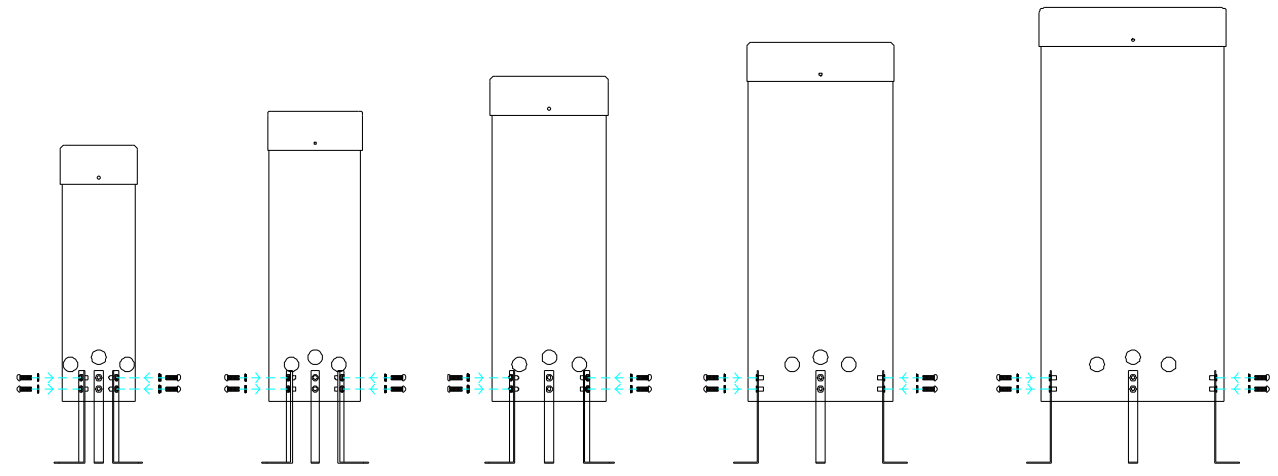

PPRASA FRONT



Played with hands

Ground Fix Components:



x34
M8x25 Security Screw



x34
M8 Lock Washer



x17
L Brackets

Spares available from
percussionplay.co.uk or from
your local distributor

47 Kg

Ground Fix Installation

Tools:



x1
TX 40 Driver Bit

Ground Fixed Rainbow Sambas Page 3 of 4

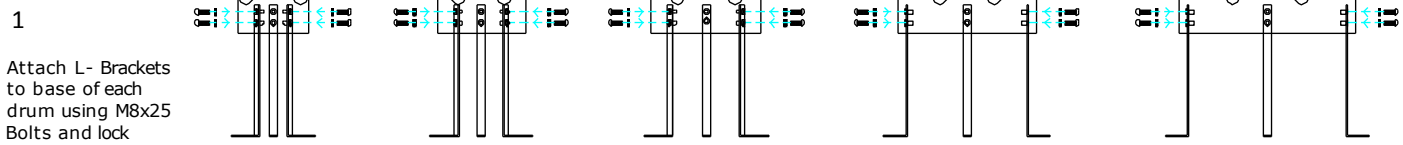

Attach L- Brackets to base of each drum using M8x25 Bolts and lock washers provided.

Components:

-  x17
M8x25mm Pin Torx
-  x34
M8 Lock Washer
-  x17
L Brackets

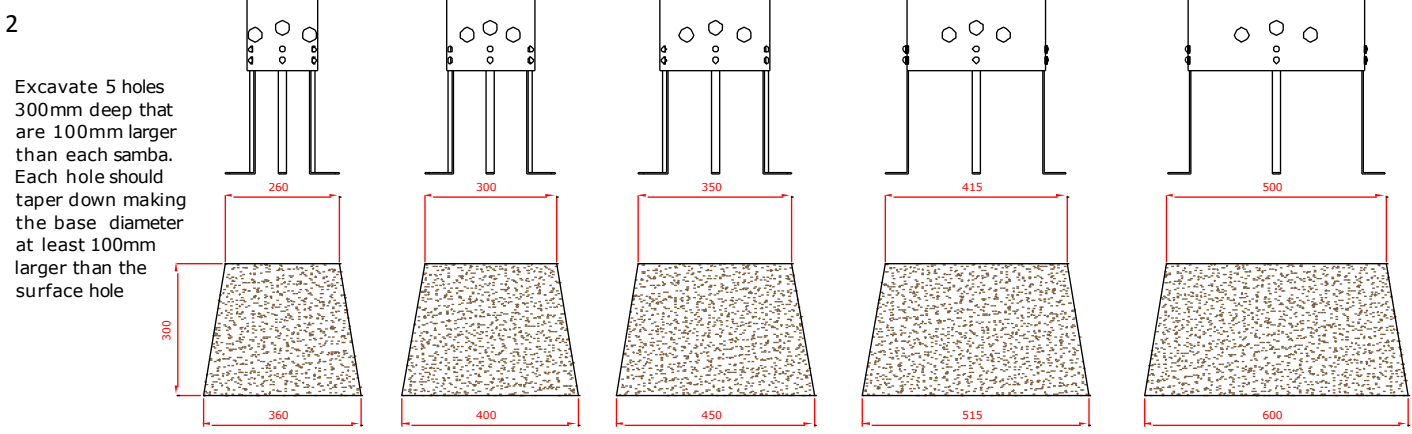

Excavate 5 holes 300mm deep that are 100mm larger than each samba. Each hole should taper down making the base diameter at least 100mm larger than the surface hole

Ground Fix Installation

Ground Fixed Rainbow Sambas Page 4 of 4



3

Compact each hole with a maximum of 65mm of aggregate and lower each samba into its hole

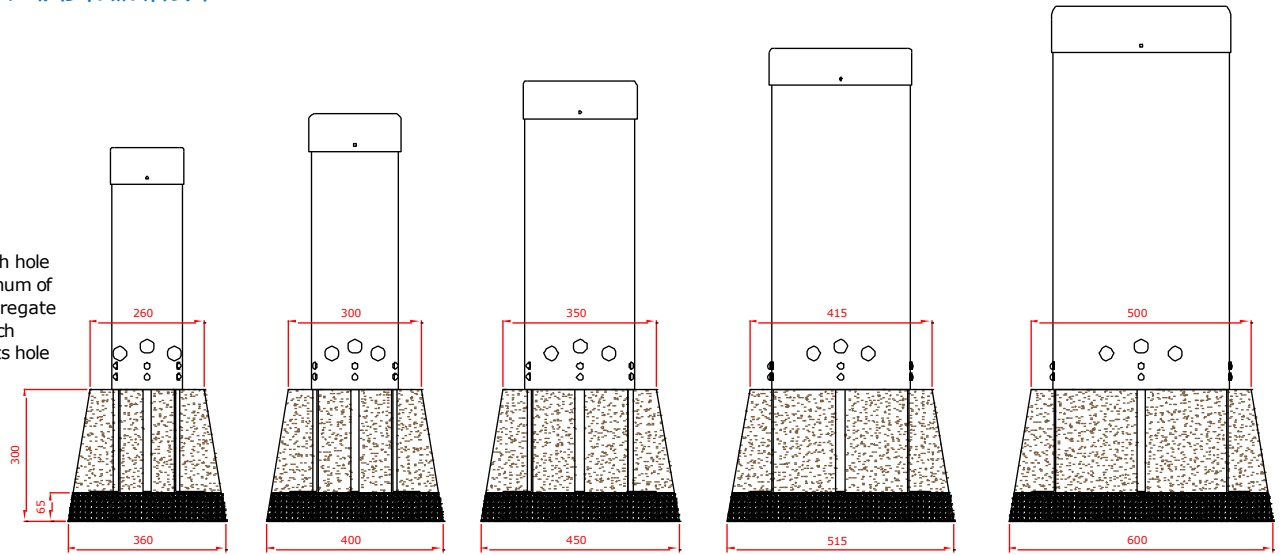

Components:

-  x17
M8x25mm Pin Torx
-  x34
M8 Lock Washer
-  x17
L Brackets

4

Fill each hole with fast drying concrete to manufacturers specifications.

