

Installation Instructions

Ground Fixed Rainbow Chime Post Page 1 of 3



Weight of heaviest part 7.5kg

1. Instrument will arrive on site fully assembled. **(1.1)**
(See Assembly Guide)

2. Attach Ground Fixing studs holes in base of centre post. **(1.2)** (See Ground Fix Post Installation Sheet)

3. Excavate 1 hole for the Steel legs **250mm diameter** by **350mm deep** in desired location upon decision from customer.

4. Locate (lower) leg into hole, making sure it is vertical and level prior to concreting in place.

5. Once happy with location of the Instrument, **fill** holes using rapid hardening **concrete**. Be sure to compact concrete around legs and leave to dry according to manufactures guidelines.

6. Attach the 1 pair of beater to the saddle strap on each side of the post. **(1.3)**

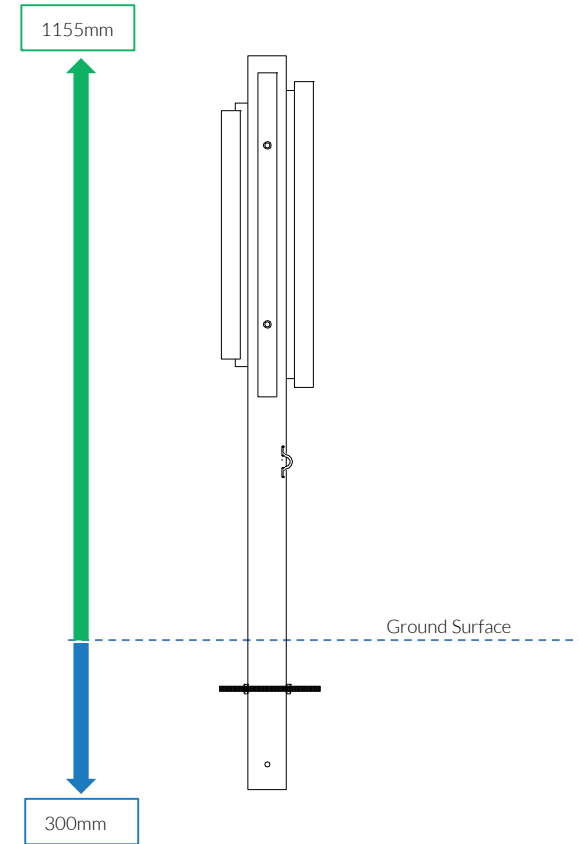
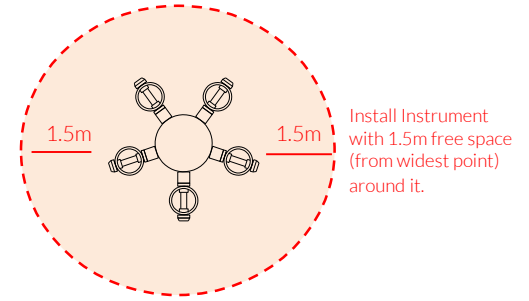

Instrument Components:

 x4
M6x20 Security Screw

 x2
M6 Saddle Strap

Metric Conversion:
250mm/ 10"
300mm/ 12"
350mm/ 14"
1155mm/ 45.5"
1.5m/ 59"



Ground Fix Components:



Spares available from percussionplay.com or from your local distributor

7.5 Kg

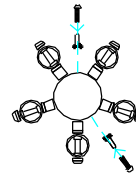

Tools:



Ground Fixed Rainbow Chime Post Page 2 of 3



Instrument Components:



x4

M6x20 Security Screw



x2

M6 Saddle Strap

Thread Lock Solution
Required (Not Supplied)

COMPONENTS LIST:



M10 Nut X4



M10x200 Threaded Bar X2



Saddle Strap X2



M6x20 Pin torx X4

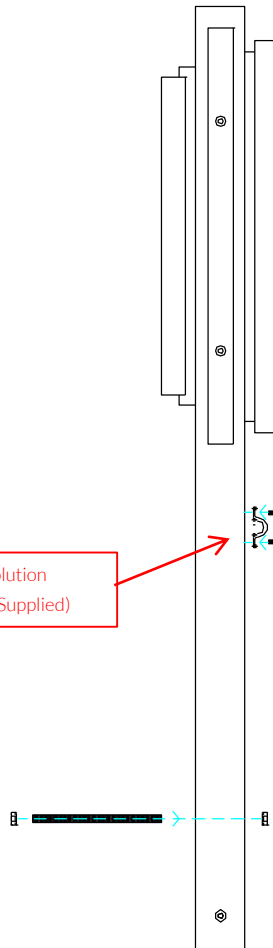

Thread Lock Solution
Required (Not Supplied)



Pair Small Red
Beaters X1

Ground Fix Components:



x2

M10x200 Bolt



x4

M10 Nut

Ground Fix Post Installation

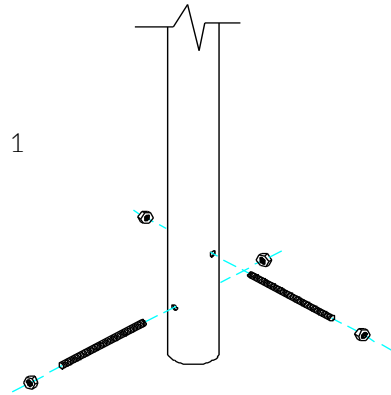

1
Insert M10x 200 Threaded bar into pre drilled holes in Ground Fixing Post

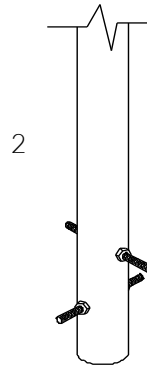

2
Fix M10x 200 Threaded bar in place using M10 Nuts

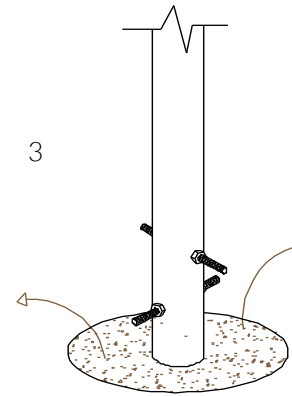

3
Excavate a hole with a 250mm diameter tapering down to 350mm diameter and 350mm depth

Foundations should not present a hazard. These foundations are recommended as a guide, for more information on foundation details for various surface see Part 7 of BS EN 1176.

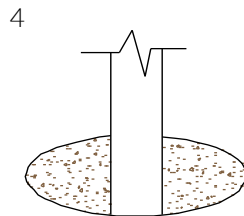

4
Compact base of hole with 50mm of aggregate. Lower ground Fix post attached of instrument into hole (check instrument straight and level before filling with concrete)

300mm min depth

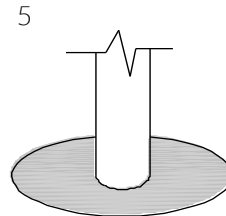

5
Fill hole with fast drying concrete to manufacturers specifications.

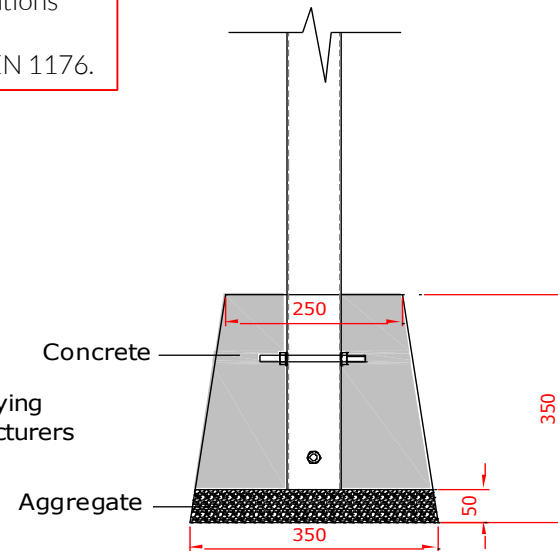

Ground Fixed Rainbow Chime Post

Page 3 of 3



Components:



Metric Conversion:
50mm/ 2"
250mm/ 10"
300mm/ 12"
350mm/ 14"